



ŞUBAT
2022

FİYAT
LİSTESİ

SIKMALI KABLO PABUÇLARI
KABLO YÜKSÜKLERİ
KABLO UÇLARI
HAT KLEMENSİ



SKP SIKMALI KABLO PABUÇLARI

EKONOMİK TİP (SKP) SIKMALI KABLO PABUCU	3
STANDART TİP (SKP) SIKMALI KABLO PABUCU	4-5
EKSTRA UZUN TİP (SKP) SIKMALI KABLO PABUCU	6
AÇILI TİP (SKP) SIKMALI KABLO PABUCU	7-8
BİMETAL AL-CU KABLO PABUCU	9
ALÜMİNYUM SIKMALI KABLO PABUCU	10



SIKMALI EK MUFLARI

STANDART TİP EK MUFLARI	11
ALÜMİNYUM EK MUFLARI	12



KABLO YÜKSÜKLERİ

İZOLELİ KABLO YÜKSÜKLERİ	13
İKİZ KABLO YÜKSÜKLERİ	14
İZOLESİZ KABLO YÜKSÜKLERİ	15



KABLO UÇLARI

YUVARLAK TİP İZOLELİ KABLO UÇLARI	16
ÇATAL TİP İZOLELİ KABLO UÇLARI	17
DİŞİ FASTON TİP İZOLELİ KABLO UÇLARI	18
TAM İZOLELİ DİŞİ FASTON TİP KABLO UÇLARI	18
ERKEK FASTON TİP TERMİNALLER	19
ERKEK/DİŞİ GERİ DÖNÜŞLÜ TERMİNALLER	19



HAT KLEMENSİ

EKONOMİK TİP PARALEL ATLAMA ALÜMİNYUM KLEMENS	20
EKONOMİK TİP DURDURUCU ALÜMİNYUM KLEMENS	20
EKONOMİK TİP BİMETAL (AL-CU) ALÜMİNYUM KLEMENS	20

ÖZEL İMALATLAR

95MM ² ÇELİK ÖRGÜLÜ TOPRAKLAMA TELİ	21
GALVANİZLİ TOPRAKLAMA PABUCU	21
GALVANİZLİ TOPRAKLAMA KLEMENSİ	21

SKP SIKMALI KABLO PABUÇLARI EKONOMİK TİP (SKP) SIKMALI KABLO PABUCU

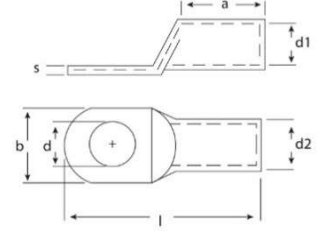

Malzeme	: EN13600 standart bakır
Yüzey	: Kalay

Sipariş Kodu	Kablo Kesiti (mm ²)	Delik Çapı ϕ	Ölçüler (mm)						Kutu/Amb. Adet	Birim Fiyatı TL/Adet
			d	d1	d2	l	a	b		
PE 16-6	16	M6	6,5	5,5	7,0	32,5	11,0	10,5	800	3,60
PE 16-8	16	M8	8,5	5,5	7,0	32,5	11,0	13,0	800	4,90
PE 25-8	25	M8	8,5	7,0	9,0	38,5	16,0	13,0	400	7,70
PE 35-8	35	M8	8,3	8,5	10,5	43,5	19,0	15,5	300	11,70
PE 50-10	50	M10	10,5	10,0	12,0	51,5	21,0	17,6	200	13,60
PE 70-10	70	M10	10,5	11,5	14,0	55,5	23,0	20,7	125	21,70
PE 95-10	95	M10	10,5	13,5	16,0	58,5	26,0	23,5	80	25,50
PE 120-12	120	M12	13,0	15,5	18,0	71,0	29,0	26,7	60	33,20
PE 150-12	150	M12	13,0	16,5	20,0	76,0	30,0	29,2	40	53,10
PE 185-16	185	M16	17,0	18,5	22,0	82,0	33,0	32,3	40	63,80
PE 240-16	240	M16	17,0	21,5	25,5	89,0	38,0	37,6	30	95,60



- * Koyu renk ile belirtilen kablo pabuçları standart üretimimizdir. Diğer ölçüler için stok durumunu sorunuz.
- * Ürünlerimiz elektrolitik bakırdan (E-Cu) tavlı, havşalı ve minimum 3 mikron kalay kaplıdır.
- * Firmamız önceden haber vermeksizin ürün ölçülerinde değişiklik yapma hakkını saklı tutar.

SKP SIKMALI KABLO PABUÇLARI

STANDART TİP (SKP) SIKMALI KABLO PABUCU

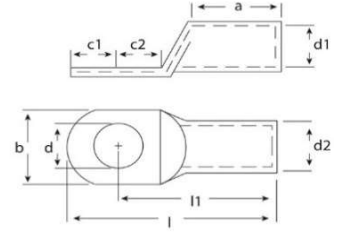

Malzeme	: EN13600 standart bakır
Yüzey	: Kalay

Sipariş Kodu	Kablo Kesiti (mm ²)	Delik Çapı Φ	Ölçüler (mm)								Kutu/ Amb. Adet	Birim Fyt. TL/Adet	
			d	d1	d2	l	l1	a	b	c1			c2
PS 10-6	10	M6	6,5	4,4	6,3	28,5	22,0	10,0	10,5	6,5	6,5	1000	4,90
PS 10-8	10	M8	8,5	4,4	6,3	30,5	22,0	10,0	13,5	8,0	8,0	1000	4,90
PS 16-6	16	M6	6,5	5,5	7,8	32,6	25,0	12,0	11,2	7,0	8,0	500	6,50
PS 16-8	16	M8	8,5	5,5	7,8	32,6	25,0	12,0	13,5	7,0	8,0	500	6,90
PS 16-10	16	M10	10,5	5,5	7,8	34,0	25,5	12,0	16,0	8,5	8,0	500	7,40
PS 16-12	16	M12	12,5	5,5	7,8	38,0	28,4	12,0	18,0	9,6	9,8	400	8,10
PS 25-6	25	M6	6,5	7,0	9,5	39,0	31,5	16,0	13,5	8,5	8,0	400	11,10
PS 25-8	25	M8	8,5	7,0	9,5	39,0	31,5	16,0	13,5	8,5	8,0	400	10,30
PS 25-10	25	M10	10,5	7,0	9,5	39,0	31,5	16,0	16,0	8,5	8,0	300	11,20
PS 25-12	25	M12	12,5	7,0	9,5	44,5	34,5	16,0	19,3	10,0	11,0	200	13,40
PS 35-6	35	M6	6,5	8,5	11,0	44,0	34,0	19,0	15,7	10,0	10,0	200	14,60
PS 35-8	35	M8	8,5	8,5	11,0	44,0	34,0	19,0	15,7	10,0	10,0	200	14,30
PS 35-10	35	M10	10,5	8,5	11,0	44,0	34,0	19,0	15,7	10,0	10,0	200	14,30
PS 35-12	35	M12	12,5	8,5	11,0	49,0	38,8	19,0	19,3	10,2	11,8	150	17,40
PS 50-8	50	M8	8,5	10,0	12,5	50,5	38,5	19,0	17,7	12,0	12,0	150	22,30
PS 50-10	50	M10	10,5	10,0	12,5	50,5	38,5	19,0	17,7	12,0	12,0	150	22,30
PS 50-12	50	M12	13,0	10,0	12,5	50,5	38,5	19,0	19,0	12,0	12,0	150	23,00
PS 50-14	50	M14	15,0	10,0	12,5	51,5	38,5	19,0	22,0	12,0	12,0	150	25,50
PS 70-8	70	M8	8,5	11,2	14,5	54,6	43,1	22,0	21,1	12,5	11,5	100	29,80
PS 70-10	70	M10	10,5	11,2	14,5	54,6	43,1	22,0	21,1	12,5	11,5	100	29,80
PS 70-12	70	M12	13,0	11,2	14,5	54,6	43,1	22,0	21,1	12,5	11,5	100	30,80
PS 70-14	70	M14	15,0	11,2	14,5	54,6	43,1	22,0	23,0	12,5	11,5	100	37,60

Fiyatlarımıza KDV dahil değildir.

SKP SIKMALI KABLO PABUÇLARI

STANDART TİP (SKP) SIKMALI KABLO PABUCU



Sipariş Kodu	Kablo Kesiti (mm ²)	Delik Çapı Φ	Ölçüler (mm)								Kutu/ Amb. Adet	Birim Fyt. TL/Adet	
			d	d1	d2	l	l1	a	b	c1			c2
PS 95-8	95	M8	8,5	13,5	16,7	58,8	48,8	26,0	24,5	10,0	12,0	70	36,10
PS 95-10	95	M10	10,5	13,5	16,7	58,8	48,8	26,0	24,5	10,0	12,0	70	35,10
PS 95-12	95	M12	13,0	13,5	16,7	58,8	48,8	26,0	24,5	10,0	12,0	70	34,40
PS 95-14	95	M14	14,5	13,5	16,7	67,7	53,7	30,0	24,8	14,0	13,0	60	44,00
PS 95-16	95	M16	16,5	13,5	16,7	72,7	56,7	30,0	26,2	16,0	16,6	60	46,10
PS 120-10	120	M10	10,5	15,5	19,0	69,0	56,0	29,0	28,0	13,0	14,5	50	48,90
PS 120-12	120	M12	13,0	15,5	19,0	69,0	56,0	29,0	28,0	13,0	14,5	50	47,80
PS 120-16	120	M16	17,0	15,5	19,0	69,0	56,0	29,0	28,0	13,0	14,5	50	46,80
PS 150-10	150	M10	10,5	16,5	16,5	76,5	60,0	30,0	30,0	16,5	16,5	40	76,50
PS 150-12	150	M12	13,0	16,5	21,0	76,5	60,0	30,0	30,0	16,5	16,5	40	74,40
PS 150-16	150	M16	17,0	16,5	21,0	76,5	60,0	30,0	30,0	16,5	16,5	40	73,50
PS 185-12	185	M12	13,0	18,5	23,0	82,5	65,5	33,0	34,0	17,0	18,0	30	87,10
PS 185-16	185	M16	17,0	18,5	23,0	82,5	65,5	33,0	34,0	17,0	18,0	30	83,90
PS 240-12	240	M12	13,0	21,0	26,0	89,0	72,0	38,0	38,0	17,0	18,0	25	117,90
PS 240-16	240	M16	17,0	21,0	26,0	89,0	72,0	38,0	38,0	17,0	18,0	25	116,50
PS 300-12	300	M12	12,5	23,5	28,5	95,0	77,0	41,0	42,0	18,0	18,0	20	145,60
PS 300-16	300	M16	16,5	23,5	28,5	95,0	77,0	41,0	42,0	18,0	18,0	20	145,60

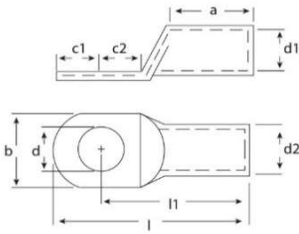

- * Koyu renk ile belirtilen kablo pabuçları standart üretimimizdir. Diğer ölçüler için stok durumunu sorunuz.
- * Ürünlerimiz elektrolitik bakırdan (E-Cu) tavlı, havşalı ve minimum 3 mikron kalay kaplıdır.
- * Firmamız önceden haber vermeksizin ürün ölçülerinde değişiklik yapma hakkını saklı tutar.

SKP SIKMALI KABLO PABUÇLARI

EKSTRA UZUN STANDART TİP (SKP) SIKMALI KABLO PABUCU

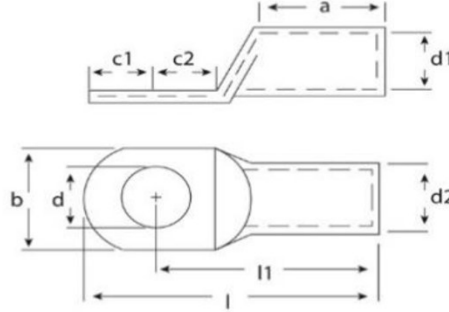

Malzeme : EN13600 standart bakır
Yüzey : Kalay

Sipariş Kodu	Kablo Kesiti (mm ²)	Delik Çapı Φ	Ölçüler (mm)									Kutu/ Amb. Adet	Birim Fyt. TL/Adet
			d	d1	d2	l	l1	a	b	c1	c2		
PSL10-6	10	M6	6,5	4,4	6,3	34,5	28,5	17,0	10,3	6,5	6,5	500	6,40
PSL10-8	10	M8	8,5	4,4	6,3	34,5	28,5	17,0	13,5	8,0	8,0	500	7,20
PSL16-6	16	M6	6,5	5,5	7,8	42,0	35,0	21,4	11,2	7,0	8,0	300	9,40
PSL16-8	16	M8	8,5	5,5	7,8	42,0	35,0	21,4	13,7	7,0	8,0	300	9,40
PSL 25-6	25	M6	6,5	7,0	9,5	51,0	44,0	28,0	13,5	8,5	8,0	250	14,50
PSL 25-8	25	M8	8,5	7,0	9,5	51,0	44,0	28,0	13,5	8,5	8,0	250	14,50
PSL 35-6	35	M6	6,5	8,5	11,0	55,0	46,5	30,0	15,7	10,0	10,0	150	19,80
PSL 35-8	35	M8	8,5	8,5	11,0	55,0	46,5	30,0	15,7	10,0	10,0	150	19,80
PSL 35-10	35	M10	10,5	8,5	11,0	55,0	46,5	30,0	15,7	10,0	12,0	150	19,80
PSL 50-8	50	M8	8,5	10,0	12,5	60,0	50,0	29,0	17,7	12,0	12,0	100	29,80
PSL 50-10	50	M10	10,5	10,0	12,5	60,0	50,0	29,0	17,7	12,0	12,0	100	29,80
PSL 50-12	50	M12	13,0	10,0	12,5	60,0	50,0	29,0	19,0	12,0	12,0	100	29,80
PSL 70-8	70	M8	8,5	11,5	14,7	70,0	60,0	38,0	21,1	10,0	12,0	75	42,50
PSL 70-10	70	M10	10,5	11,5	14,7	70,0	60,0	38,0	21,1	12,5	11,5	75	42,50
PSL 70-12	70	M12	13,0	11,5	14,7	70,0	60,0	38,0	21,1	12,5	11,5	75	42,50
PSL 95-8	95	M8	8,5	13,5	16,7	76,0	66,0	43,0	24,5	10,0	12,0	50	52,90
PSL 95-10	95	M10	10,5	13,5	16,7	76,0	66,0	43,0	24,5	10,0	12,0	50	52,90
PSL 95-12	95	M12	13,0	13,5	16,7	76,0	66,0	43,0	24,5	10,0	12,0	50	52,90
PSL 120-10	120	M10	10,5	15,5	19,0	85,0	72,0	45,0	28,0	13,0	14,5	40	64,80
PSL 120-12	120	M12	13,0	15,5	19,0	85,0	72,0	45,0	28,0	13,0	14,5	40	63,80
PSL 120-16	120	M16	17,0	15,5	19,0	85,0	72,0	45,0	28,0	13,0	14,5	40	63,80
PSL 150-10	150	M10	10,5	16,5	21,0	86,0	70,0	40,0	30,0	16,5	16,5	30	99,90
PSL 150-12	150	M12	13,0	16,5	21,0	86,0	70,0	40,0	30,0	16,5	16,5	30	97,80
PSL 150-16	150	M16	17,0	16,5	21,0	86,0	70,0	40,0	30,0	16,5	16,5	30	99,90
PSL 185-12	185	M12	13,0	18,5	23,0	95,0	78,0	47,0	34,0	17,0	18,0	20	114,80
PSL 185-16	185	M16	17,0	18,5	23,0	95,0	78,0	47,0	34,0	17,0	18,0	20	112,60
PSL 240-12	240	M12	13,0	21,0	26,0	104,0	87,0	53,0	38,0	17,0	18,0	20	157,30
PSL 240-16	240	M16	17,0	21,0	26,0	104,0	87,0	53,0	38,0	17,0	18,0	20	155,10

Fiyatlarımıza KDV dahil değildir.

AÇILI SIKMALI KABLO PABUCU

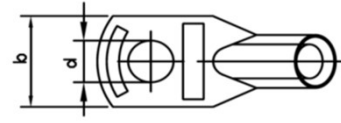
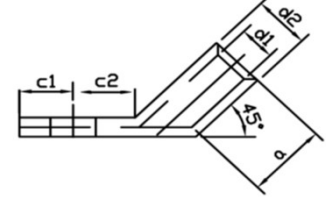

Malzeme	: EN13600 standart bakır
Yüzey	: Kalay

Sipariş Kodu	Kablo Kesiti (mm ²)	Delik Çapı Φ	Ölçüler (mm)							Kutu/ Amb. Adet	Birim Fyt. TL/Adet
			d	d1	d2	a	b	c1	c2		
PS 10-6/45	M6	6,5	6,5	4,4	6,3	11,5	12,0	5,5	7,0	500	6,00
PS 16-6/45	M6	6,5	6,5	5,5	7,8	13,0	13,0	5,5	6,5	400	8,10
PS 25-8/45	M8	8,5	8,5	7,0	9,5	17,5	13,5	6,8	9,2	300	12,80
PS 35-8/45	M8	8,5	8,5	8,5	11,0	20,0	16,0	8,3	9,7	200	17,40
PS 50-10/45	M10	10,5	10,5	10,1	13,0	22,5	18,0	10,0	12,0	100	27,20
PS 70-10/45	M10	10,5	10,5	11,5	14,7	24,0	21,5	10,0	12,0	80	38,90
PS 95-10/45	M10	10,5	10,5	13,5	16,7	27,0	25,0	10,0	12,0	60	48,90
PS 120-12/45	M12	12,5	12,5	15,5	19,0	30,0	29,0	13,0	14,5	40	61,60
PS 150-12/45	M12	12,5	13,0	16,5	21,0	30,0	31,0	14,0	17,0	30	93,50
PS 185-16/45	M16	16,5	16,5	18,5	23,0	34,5	37,0	17,0	18,0	20	106,30
PS 240-16/45	M16	16,5	16,5	21,0	26,0	35,0	41,0	17,0	18,0	15	144,50

AÇILI SIKMALI KABLO PABUCU

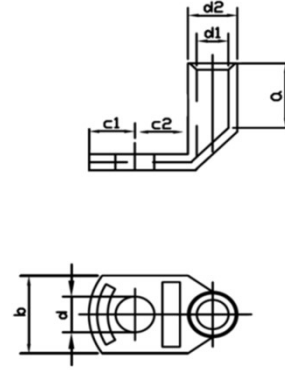

Malzeme	: EN13600 standart bakır
Yüzey	: Kalay

Sipariş Kodu	Kablo Kesiti (mm ²)	Delik Çapı Φ	Ölçüler (mm)							Kutu/ Amb. Adet	Birim Fyt. TL/Adet
			d	d1	d2	a	b	c1	c2		
PS 10-6/90	10	M6	6,5	4,4	6,3	11,5	12,0	5,5	7,0	500	6,00
PS 16-6/90	16	M6	6,5	5,5	7,8	13,0	12,0	5,5	6,5	400	8,10
PS 25-8/90	25	M8	8,5	7,0	9,5	17,5	13,5	6,8	9,2	300	12,80
PS 35-8/90	35	M8	8,5	8,5	11,0	20,0	16,0	8,3	9,7	200	17,40
PS 50-10/90	50	M10	10,5	10,1	13,0	22,5	18,0	10,0	12,0	100	27,20
PS 70-10/90	70	M10	10,5	11,5	14,7	24,0	21,5	10,0	12,0	80	38,90
PS 95-10/90	95	M10	10,5	13,5	16,7	27,0	25,0	10,0	12,0	60	48,90
PS 120-12/90	120	M12	12,5	15,5	19,0	30,0	29,0	13,0	14,5	40	61,60
PS 150-12/90	150	M12	12,5	16,5	21,0	30,0	31,0	14,0	17,0	30	93,50
PS 185-16/90	185	M16	16,5	18,5	23,0	34,5	37,0	17,0	18,0	20	106,30
PS 240-16/90	240	M16	16,5	21,0	26,0	35,0	41,0	17,0	18,0	15	144,50

SKP SIKMALI KABLO PABUÇLARI BİMETAL AL-CU KABLO PABUCU



Sipariş Kodu	Kablo Kesiti (mm ²)	Delik Çapı Φ	Ölçüler (mm)		Kutu/ Amb. Adet	Birim Fyt. TL/Adet
			d	l		
PBM 16	16	M8	8,5	84,0	80	51,00
PBM 25	25	M8	8,5	84,0	80	51,00
PBM 35	35	M8	8,5	84,0	80	51,00
PBM 50	50	M10	10,0	84,0	60	61,60
PBM 70	70	M10	10,0	84,0	60	61,60
PBM 95	95	M12	13,0	84,0	60	61,60
PBM 120	120	M12	13,0	107,0	30	110,50
PBM 150	150	M12	13,0	107,0	30	110,50
PBM 185	185	M12	13,0	117,0	15	178,50
PBM 240	240	M12	13,0	117,0	15	178,50
PBM 300	300	M16	17,0	135,0	15	276,30
PBM 400	400	M16	17,0	135,0	5	478,10

SKP SIKMALI KABLO PABUCU ALÜMİNYUM SIKMALI KABLO PABUCU

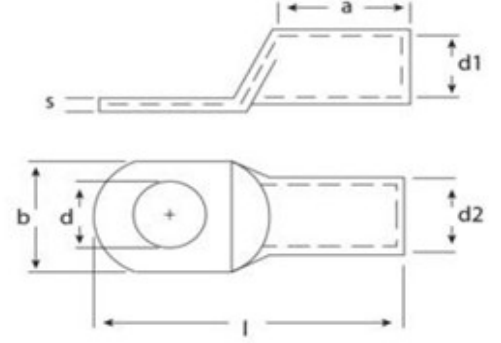

Malzeme	: E-Al
Yüzey	: Parlak

Sipariş Kodu	Kablo Kesiti (mm ²)	Delik Çapı Φ	Ölçüler (mm)						Kutu/Amb. Adet	Birim Fyt. TL/Adet
			d	d1	d2	l	a	b		
PA 16-8	16	M8	8,5	6	10	60	35	13	250	6,30
PA 25-8	25	M8	8,5	7	12	60	35	17	150	8,40
PA 35-8	35	M8	8,5	8,2	14	75	40	18	100	10,50
PA 50-10	50	M10	10,5	10	16	80	45	20	80	14,00
PA 70-10	70	M10	10,5	11,5	17,5	90	50	23	60	21,00
PA 95-12	95	M12	13	13,5	22	100	60	30	40	26,30
PA 120-12	120	M12	13	14,8	22	100	60	30	40	29,80
PA 150-12	150	M12	13	16,5	25	120	70	33	25	42,10
PA 185-16	185	M16	17	18,5	28,5	130	75	38	20	56,10
PA 240-16	240	M16	17	21	32	140	75	43	14	70,10

SIKMALI KABLO PABUÇLARI STANDART TİP EK MUFLAR



Malzeme	: EN13600 standart bakır
Yüzey	: Kalay

Sipariş Kodu	Kablo Kesiti (mm ²)	Ölçüler (mm)			Kutu/Amb. Adet	Birim Fyt. TL/Adet
		d1	d2	l		
PEM 10	10	4,4	6,3	29,0	1000	5,60
PEM 16	16	5,5	7,8	33,5	400	7,40
PEM 25	25	7,0	9,2	40,0	250	11,30
PEM 35	35	8,2	11,0	46,0	150	15,30
PEM 50	50	10,0	12,5	52,0	90	25,90
PEM 70	70	11,2	14,5	56,5	65	34,40
PEM 95	95	13,4	16,8	61,5	50	36,10
PEM 120	120	15,5	19,0	72,0	40	49,30
PEM 150	150	16,5	21,0	80,0	25	77,60
PEM 185	185	18,5	23,0	86,0	22	93,90
PEM 240	240	21,0	26,0	94,0	18	127,50



- * Koyu renk ile belirtilen kablo pabuçları standart üretimimizdir. Diğer ölçüler için stok durumunu sorunuz.
- * Ürünlerimiz elektrolitik bakırdan (E-Cu) tavlı, havşalı ve minimum 3 mikron kalay kaplıdır.
- * Firmamız önceden haber vermeksizin ürün ölçülerinde değişiklik yapma hakkını saklı tutar.

Fiyatlarımıza KDV dahil değildir.

SKP SIKMALI KABLO PABUCU ALÜMİNYUM SIKMALI EK MUFU

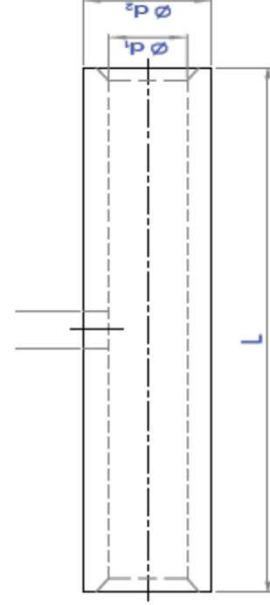

Sipariş Kodu	Kablo Kesiti (mm ²)	Ölçüler (mm)			Kutu/Amb. Adet	Birim Fyt. TL/Adet
		d1	d2	l		
PAM 16	16	6	10	60	250	4,90
PAM 25	25	7	8,5	60	150	6,30
PAM 35	35	8,2	8,5	75	100	9,80
PAM 50	50	10	10,5	80	80	14,00
PAM 70	70	11,5	10,5	90	60	17,50
PAM 95	95	13,5	13	100	40	24,50
PAM 120	120	14,8	13	100	40	26,30
PAM 150	150	16,5	13	120	25	40,30
PAM 185	185	18,5	17	130	20	49,10
PAM 240	240	21	17	140	14	63,10

KABLO YÜKSÜKLERİ İZOLELİ KABLO YÜKSÜKLERİ

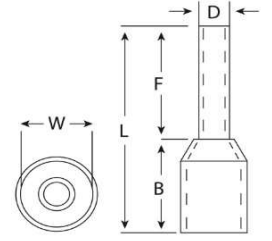

Sipariş Kodu	Ölçüler (mm)					Renk	Ambalaj Miktarı	Birim Fyt. TL/Adet
	F	L	W	B	D			
PIY-0,25/MV	8	12	1,90	4,40	1,10	Mavi	1000	0,145
PIY-0,34/TR	8	12	1,90	4,40	1,10	Turkuaz	1000	0,109
PIY-0,5/TR	8	14	2,60	6,00	1,30	Turuncu	1000	0,065
PIY-0,75/BY	8	14	2,80	6,30	1,50	Beyaz	1000	0,066
PIY-1/SR	8	14	3,00	6,30	1,70	Sarı	1000	0,070
PIY-1,5/KR	8	14	3,50	6,30	2,00	Kırmızı	1000	0,082
PIY-2,5/MV	8	14	4,20	7,40	2,50	Mavi	500	0,096
PIY-4/GR	10	17	4,80	7,40	3,20	Gri	500	0,154
PIY-6/SY	12	20	6,30	8,50	3,90	Siyah	250	0,204
PIY-10/BJ	12	22	7,60	8,80	4,90	Bej	100	0,300
PIY-16/YS	12	24	8,80	10,00	6,20	Yeşil	100	0,360
PIY-25/KH	16	28	11,20	12,00	7,70	Kahverengi	50	0,720
PIY-35/BJ	16	30	12,70	14,00	8,70	Bej	50	0,840
PIY-50/YS	20	36	15,00	16,00	10,90	Yeşil	25	1,700
PIY-70/SR	20	37	16,00	17,00	14,3	Sarı	25	3,400



Fiyatlarımıza KDV dahil değildir.



KABLO YÜKSÜKLERİ İKİZ KABLO YÜKSÜKLERİ

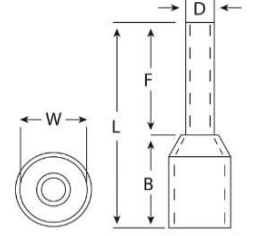

Sipariş Kodu	Ölçüler (mm)					Renk	Ambalaj Miktarı	Birim Fyt. TL/Adet
	F	L	W	B	D			
PIKY-2X0,5	8	14	5,00	6,50	1,80	Turuncu	1000	0,122
PIKY-2X0,75	8	14	5,50	6,70	2,10	Beyaz	500	0,123
PIKY-2X1	8	14	5,50	7,10	2,40	Sarı	500	0,128
PIKY-2X1,5	8	14	6,40	7,50	2,60	Kırmızı	500	0,144
PIKY-2X2,5	10	14	8,00	8,50	3,30	Mavi	250	0,232
PIKY-2X4	12	17	8,00	11,10	4,20	Gri	200	0,302
PIKY-2X6	14	20	9,50	12,10	5,30	Siyah	100	0,400
PIKY-2X10	14	27	12,60	12,60	6,90	Bej	50	0,580
PIKY-2X16	14	31	19,00	17,30	8,70	Yeşil	50	0,900



KABLO YÜKSÜKLERİ İZOLESİZ KABLO YÜKSÜKLERİ

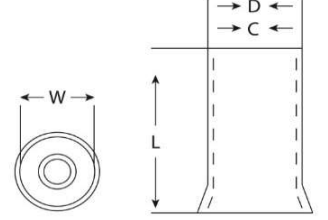

Sipariş Kodu	Ölçüler (mm)				Ambalaj Miktarı	Birim Fyt. TL/Adet
	L	W	D	C		
PY-0,5	10	2,10	1,30	1,00	2000	0,057
PY-0,75	10	2,30	1,50	1,20	1000	0,058
PY-1	10	2,50	1,70	1,40	1000	0,060
PY-1,5	10	2,80	2,00	1,70	1000	0,068
PY-2,5	12	3,40	2,50	2,20	1000	0,080
PY-4	12	4,00	3,20	2,80	1000	0,122
PY-6	12	4,70	3,90	3,50	500	0,168
PY-10	15	5,80	4,90	4,50	250	0,230
PY-16	15	7,50	6,20	5,80	250	0,270
PY-25	16	9,10	7,90	7,50	100	0,540
PY-35	16	10,20	8,70	8,30	100	0,640
PY-50	20	12,70	10,90	10,30	50	1,280



Fiyatlarımıza KDV dahil değildir.

KABLO UÇLARI

YUVARLAK TİP İZOLELİ KABLO UÇLARI



Standart : DIN 46237
Malzeme : Bakır, Kalay Kaplı
İzolasyon : PVC
Çalışma Sıcaklığı : Max. 105° 600 V

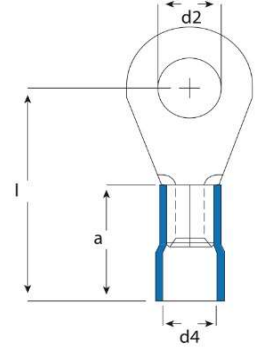

Sipariş Kodu	Kablo Kesiti (mm ²)	Cıvata Ölçüsü	Ölçüler (mm)				Ambalaj Miktarı	Birim Fyt. TL/Adet
			d2	l	d4	a		
PHT 0,5-1,5/3	0,50-1,50 mm ²	M3	3,2	14,0	4,0	10,0	200	0,151
PHT 0,5-1,5/4		M4	4,3	16,3	4,0	10,0	200	0,236
PHT 0,5-1,5/5		M5	5,3	17,0	4,0	10,0	200	0,239
PHT 0,5-1,5/6		M6	6,5	21,0	4,0	10,0	200	0,379
PHT 0,5-1,5/8		M8	8,4	21,0	4,0	10,0	200	0,385
PHT 1,5-2,5/3	1,50-2,50 mm ²	M3	3,2	14,3	4,5	10,0	200	0,281
PHT 1,5-2,5/4		M4	4,3	16,3	4,5	10,0	200	0,294
PHT 1,5-2,5/5		M5	5,3	17,8	4,5	10,0	200	0,301
PHT 1,5-2,5/6		M6	6,5	21,0	4,5	10,0	200	0,418
PHT 1,5-2,5/8		M8	8,4	21,0	4,5	10,0	200	0,424
PHT 1,5-2,5/10	M10	10,5	23,9	4,5	10,0	100	0,432	
PHT 4-6/4	4-6 mm ²	M4	4,3	18,4	6,5	12,5	75	0,606
PHT 4-6/5		M5	5,3	20,8	6,5	12,5	75	0,612
PHT 4-6/6		M6	6,5	23,0	6,5	12,5	75	0,690
PHT 4-6/8		M8	8,4	26,2	6,5	12,5	75	0,885
PHT 4-6/10		M10	10,5	26,2	6,5	12,5	75	0,898
PHT 4-6/10	M12	13,0	28,5	6,5	12,5	75	0,911	
PHT 8-10/5	8-10 mm ²	M5	5,3	26,7	8,0	17,0	50	1,285
PHT 8-10/6		M6	6,7	26,7	8,0	17,0	50	1,480



KABLO UÇLARI ÇATAL TİP İZOLELİ KABLO UÇLARI



Standart : DIN 46237
Malzeme : Bakır, Kalay Kaplı
İzolasyon : PVC
Çalışma Sıcaklığı : Max. 105° 600 V

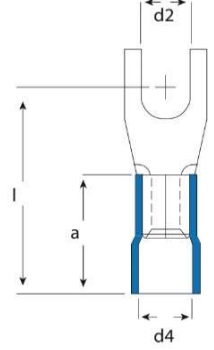

Sipariş Kodu	Kablo Kesiti (mm ²)	Cıvata Ölçüsü	Ölçüler (mm)				Ambalaj Miktarı	Birim Fyt. TL/Adet
			d2	l	d4	a		
PÇT 0,5-1,5/3	0,50-1,50 mm ²	M3	3,2	16,3	4,1	10,0	200	0,210
PÇT 0,5-1,5/4		M4	4,3	16,3	4,1	10,0	200	0,223
PÇT 0,5-1,5/5		M5	5,3	17,0	4,1	10,0	200	0,232
PÇT 0,5-1,5/6		M6	6,5	21,0	4,1	10,0	200	0,255
PÇT 1,5-2,5/3	1,50-2,50 mm ²	M3	3,2	16,3	4,5	10,0	200	0,236
PÇT 1,5-2,5/4		M4	4,3	16,3	4,5	10,0	200	0,242
PÇT 1,5-2,5/5		M5	5,3	17,2	4,5	10,0	200	0,245
PÇT 1,5-2,5/6		M6	6,5	21,0	4,5	10,0	200	0,333
PÇT 4-6/4	4-6 mm ²	M4	4,3	20,0	6,5	12,5	75	0,521
PÇT 4-6/5		M5	5,3	20,0	6,5	12,5	75	0,528
PÇT 4-6/6		M6	6,5	20,0	6,5	12,5	75	0,716
PÇT 4-6/8		M8	8,4	23,0	6,5	12,5	75	0,833



Fiyatlarımıza KDV dahil değildir.

KABLO UÇLARI

DİŐİ FASTON TİP İZOLELİ KABLO UÇLARI



Malzeme : Pirinç, Kalay Kaplı
İzolasyon : PVC
Çalışma Sıcaklığı : Max. 75° 300 V

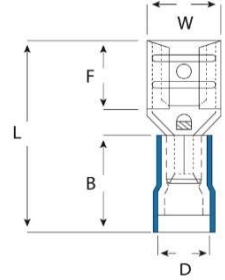

Sipariş Kodu	Kablo Kesiti (mm ²)	Soket Geniřliđi	Ölçüler (mm)					Ambalaj Miktarı	Birim Fyt. TL/Adet
			W	F	L	B	D		
PFD-1288		0,8x2,80	3,2	6,5	19,0	10,5	3,8	200	0,255
PFD-1488	0,50-1,50 mm ²	0,8x4,75	5,0	6,4	19,4	10,5	3,8	200	0,320
PFD-1638		0,8x6,35	6,6	7,5	20,8	10,5	3,8	200	0,418
PFD-2288		0,8x2,80	3,2	6,5	19,0	10,5	4,7	150	0,320
PFD-2488	1,50-2,50 mm ²	0,8x4,75	5,0	6,4	19,4	10,5	4,7	150	0,372
PFD-2638		0,8x6,35	6,6	7,5	20,8	10,5	4,7	150	0,418
PFD-5638	4-6 mm ²	0,8x6,35	6,6	7,5	23,3	13,0	6,2	100	0,502

KABLO UÇLARI

TAM İZOLELİ DİŐİ FASTON TİP KABLO UÇLARI



Malzeme : Pirinç, Kalay Kaplı
İzolasyon : PVC
Çalışma Sıcaklığı : Max. 75° 300 V

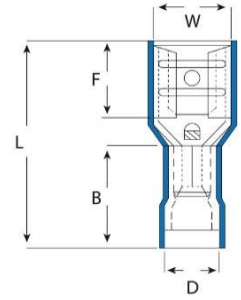

Sipariş Kodu	Kablo Kesiti (mm ²)	Soket Geniřliđi	Ölçüler (mm)					Ambalaj Miktarı	Birim Fyt. TL/Adet
			W	F	L	B	D		
PFFD-1288		0,8x2,80	3,2	6,5	19,0	10,5	3,8	200	0,386
PFFD-1488	0,50-1,50 mm ²	0,8x4,75	5,0	6,4	20,5	10,5	3,8	200	0,388
PFFD-1638		0,8x6,35	6,6	7,5	21,8	10,5	3,8	200	0,554
PFFD-2288		0,8x2,80	3,2	6,4	20,0	10,5	4,7	100	0,398
PFFD-2488	1,50-2,50 mm ²	0,8x4,75	5,0	6,4	20,2	10,5	4,7	100	0,399
PFFD-2638		0,8x6,35	6,6	7,5	22,2	10,5	4,7	100	0,554
PFFD-5638	4-6 mm ²	0,8x6,35	6,6	7,5	24,2	12,5	6,2	75	0,588

KABLO UÇLARI ERKEK FASTON TİP TERMİNALLER

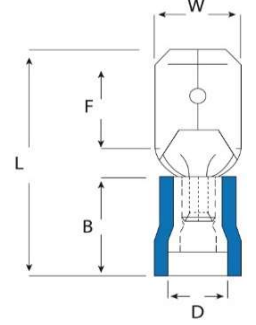

Sipariş Kodu	Kablo Kesiti (mm ²)	Soket Genişliği	Ölçüler (mm)					Ambalaj Miktarı	Birim Fyt. TL/Adet
			W	F	L	B	D		
PFE-1288	0,50-1,50 mm ²	0,8x2,80	2,8	6,5	19,2	10,5	3,8	200	0,288
PFE-1488		0,8x4,75	4,8	6,7	19,8	10,5	3,8	200	0,289
PFE-1638		0,8x6,35	6,35	7,7	21,8	10,5	3,8	200	0,353
PFE-2288	1,50-2,50 mm ²	0,8x2,80	4,8	6,7	19,8	10,5	4,7	200	0,288
PFE-2488		0,8x4,75	4,8	6,7	19,8	10,5	4,7	200	0,289
PFE-2638		0,8x6,35	6,35	7,7	21,8	10,5	4,7	200	0,372
PFE-5638	4-6 mm ²	0,8x6,35	6,35	7,7	24,8	13,0	6,2	100	0,437

Malzeme : Pirinç, Kalay Kaplı
İzolasyon : PVC
Çalışma Sıcaklığı : Max. 75° 300 V

KABLO UÇLARI ERKEK-DİŞİ GERİ DÖNÜŞLÜ TERMİNALLER

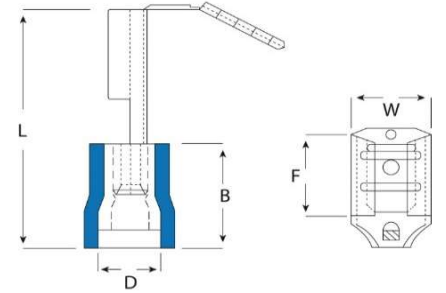

Sipariş Kodu	Kablo Kesiti (mm ²)	Soket Genişliği	Ölçüler (mm)					Ambalaj Miktarı	Birim Fyt. TL/Adet
			W	F	L	B	D		
PFDEG-1861	0,50-1,50 mm ²	0,8x6,35	6,6	8,0	22,5	10,5	3,8	100	0,970
PFDEG-2862	1,50-2,50 mm ²	0,8x6,35	6,6	8,0	22,5	10,5	4,7	100	0,970
PFDEG-5866	4-6 mm ²	0,8x6,35	6,6	8,0	24,0	13,0	6,2	100	1,060

Malzeme : Pirinç, Kalay Kaplı
İzolasyon : PVC
Çalışma Sıcaklığı : Max. 75° 300 V

Fiyatlarımıza KDV dahil değildir.

HAT KLEMENSİ

EKONOMİK TİP BRANŞMAN (PARALEL ATLAMA) ALÜMİNYUM KLEMENS



Ürün Tipi	Sıkma Sahası mm ²	Kullanıldığı İletkenler	Ambalaj Miktarı	Birim Fyt. TL/Adet
A25 - A25	6-25	Rose	600	9.2
A40 - A40	16-40	Rose, Lily, Swallow, Sparrow	500	11.1
A70 - A70	16-70	Rose, Lily, Swallow, Sparrow, Pansy	250	18.0
A120 - A120	40-120	Pansy, Aster, Phlox, Oxlip, Rawen, Pigeon	125	32.0
A240 - A240	70-240	Daisy, Peony, Tulip, Canna, Patridge, Ostrich, Hawk	40	95.0

EKONOMİK TİP BİMETAL (AL-CU) ALÜMİNYUM KLEMENS



Ürün Tipi	Sıkma Sahası mm ²	Kullanıldığı İletkenler	Ambalaj Miktarı	Birim Fyt. TL/Adet
A25 - B16	6-25AL/2.5-16CU	Rose	500	11.8
A40 - B25	16-40AL/10-25CU	Rose, Lily, Swallow, Sparrow	500	14.8
A70 - B50	16-70AL/10-50CU	Rose, Lily, Swallow, Sparrow	250	21.8
A120 - B70	70-120AL/10-70CU	Pansy, Aster, Phlox, Oxlip, Rawen, Pigeon	125	45.0
A240 - B120	70-240AL/50-120CU	Daisy, Peony, Tulip, Canna, Patridge, Ostrich, Hawk	40	92.0

EKONOMİK TİP DURDURUCU ALÜMİNYUM KLEMENS



Ürün Tipi	Sıkma Sahası mm ²	Kullanıldığı İletkenler	Ambalaj Miktarı	Birim Fyt. TL/Adet
16 - A50	16 - 50	Rose, Lily, Swallow, Sparrow	250	17.0
50 - A95	50 - 95	Popy, Aster, Phlox, Rabinone, Rawen	150	32.0

ÖZEL İMALATLAR

95 mm² ÇELİK ÖRGÜLÜ TOPRAKLAMA TELİ

Ürün Tipi	Uzunluk (m)	Ambalaj Miktarı	Birim Fyt. TL/Adet
1x95 mm ² Çelik Tel	3	1	Sorunuz
1x95 mm ² Çelik Tel	5	1	Sorunuz
1x95 mm ² Çelik Tel	15	1	Sorunuz

GALVANİZLİ TOPRAKLAMA PABUCU



Ürün Tipi	Ambalaj Miktarı	Birim Fyt. TL/Adet
95 mm ² Tek Delikli	1	Sorunuz
95 mm ² Çift Delikli	1	Sorunuz

GALVANİZLİ TOPRAKLAMA KLEMENSİ



Ürün Tipi	Ambalaj Miktarı	Birim Fyt. TL/Adet
95 mm ² Galvanizli Topraklama Klemensi	1	Sorunuz

Fiyatlarımıza KDV dahil değildir.

- Bu fiyat listesi Şubat 2022 tarihinden itibaren geçerli olan liste fiyatlarımızı içermektedir.
- Fiyatlarımızda önceden herhangi bir uyarıya gerek kalmaksızın deęişiklik yapma hakkımız saklıdır.
- Fiyatlarımıza KDV dahil deęildir.
- Listemizde fiyatı bulunmayan ürünler için lütfen satış birimimiz ile iletişime geçiniz.
- Nakliye ücreti alıcıya aittir.
- Ürünlerimize ait çizim, görsel, fotoğraf vb. dökümanlar Past Elektrik İnşaat Mühendislik İmalat San. ve Tic. Ltd. Şti. izni olmadan kullanılamaz/kopyalanamaz.



Ulubey Mah. Altındamla Sok.
18/2 Siteler Altındaę Ankara
Tel: 0312 348 72 78

info@pastelektrik.com
www.pastelektrik.com